



Chemistry 4631

Instrumental Analysis

Lecture 28

High Performance Liquid Chromatography (HPLC)

Instrumentation

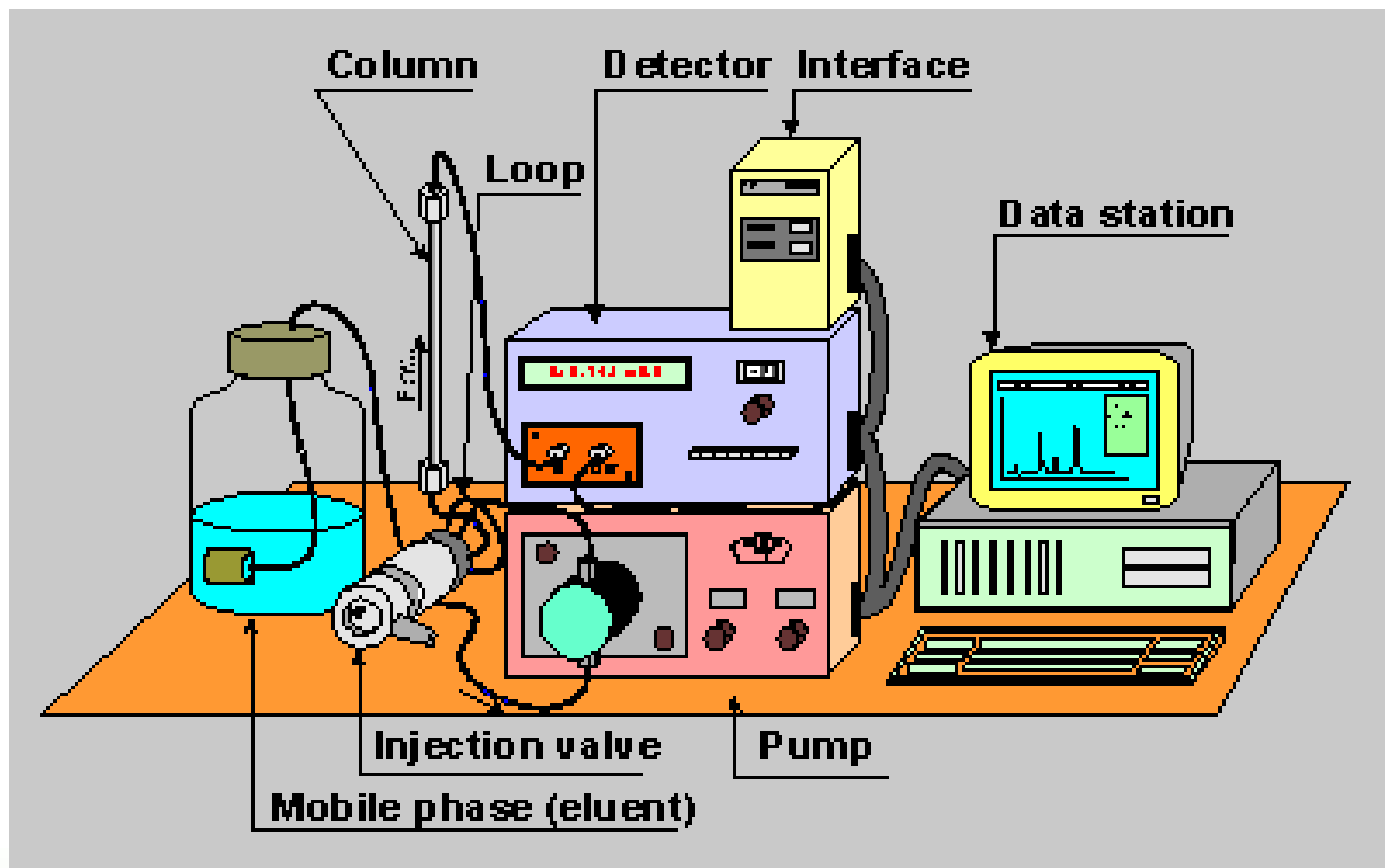

High Performance Liquid Chromatography (HPLC) Instrumentation

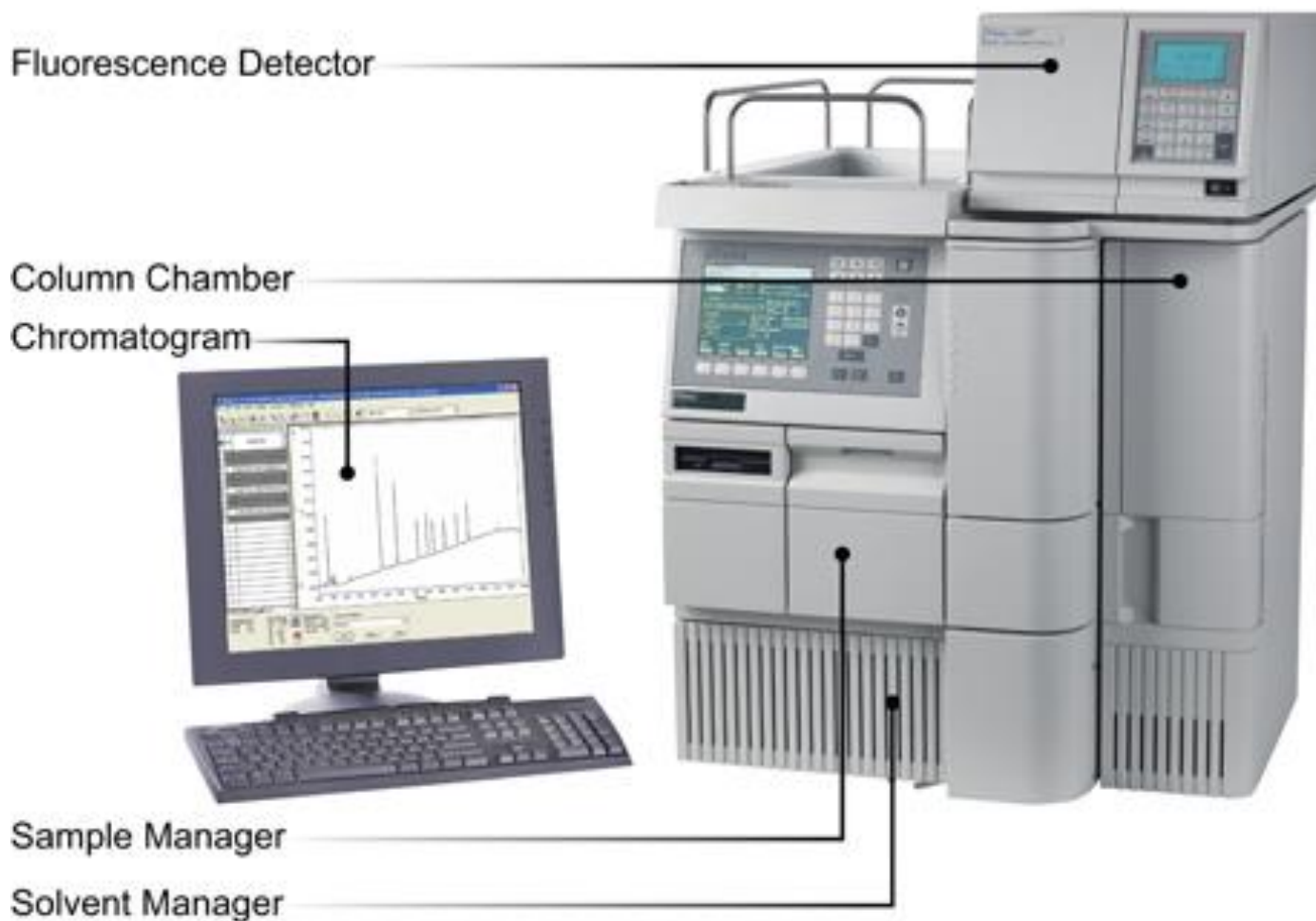

High Performance Liquid Chromatography (HPLC)

Instrumentation

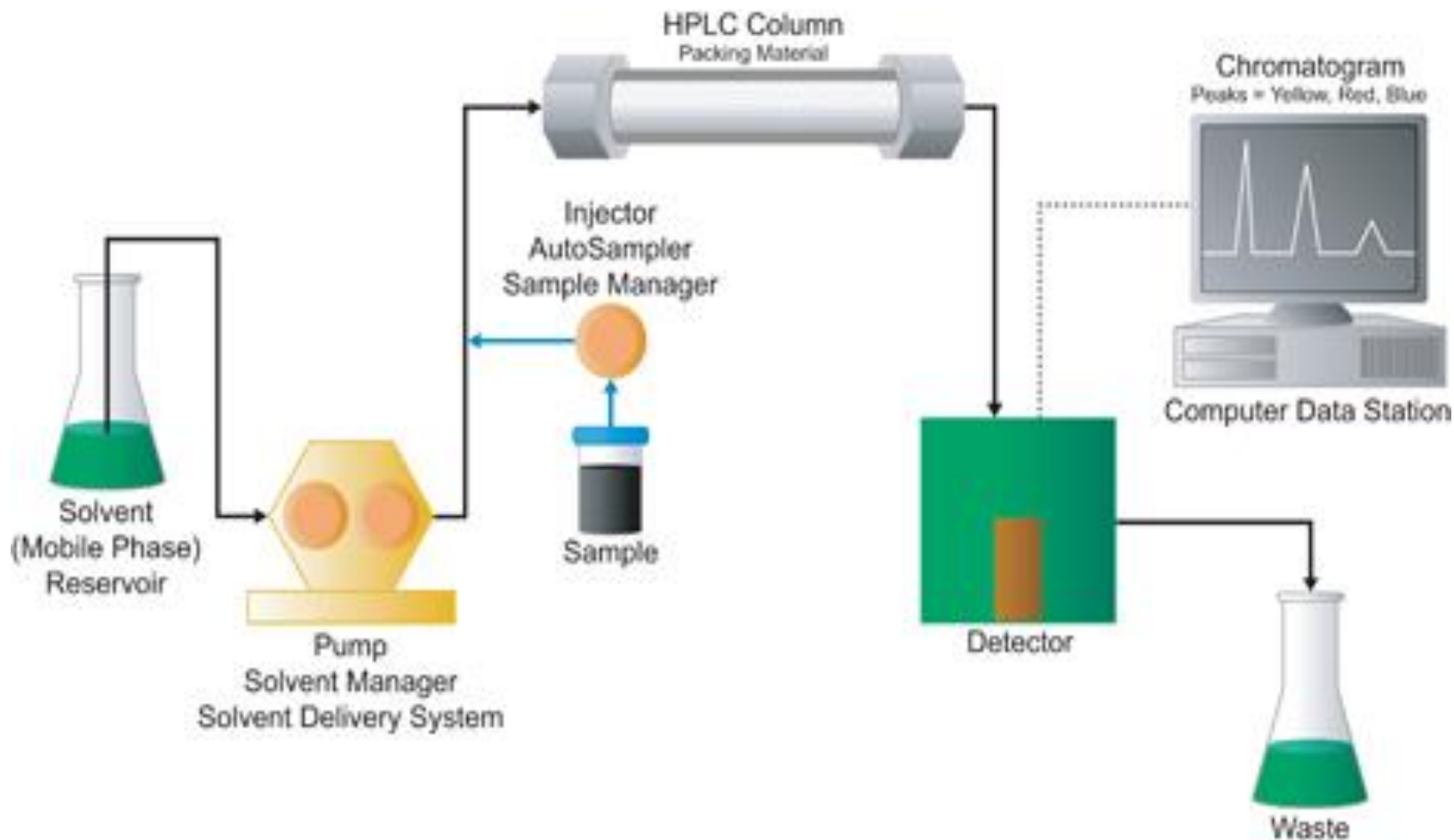

HPLC

Instrumentation

Solvent Delivery Systems - Mobile phase reservoirs

Typically glass

The solvent feed line – nonpermeable Teflon.

Mobile phases – are degassed (to minimize dissolved gases and bubbles in pump) and filtered (0.22 – 0.45 μ m filter) immediately prior to use.

Sparging – bubbling a gas through the solvent such as N₂ or He (better less dissolved in solvent) reduces background absorbance for a U.V. detector and O₂ for a fluorescence detector.

HPLC

Instrumentation

Solvent Delivery Systems

Isocratic - mobile phase is kept constant throughout the analysis. Delivers only one solvent system.

Gradient - capable of delivering more than one solvent during analysis.

**Solvents can be blended by two different ways:
High Pressure Mixing and Low Pressure Mixing**

HPLC

Instrumentation

Solvent Delivery Systems

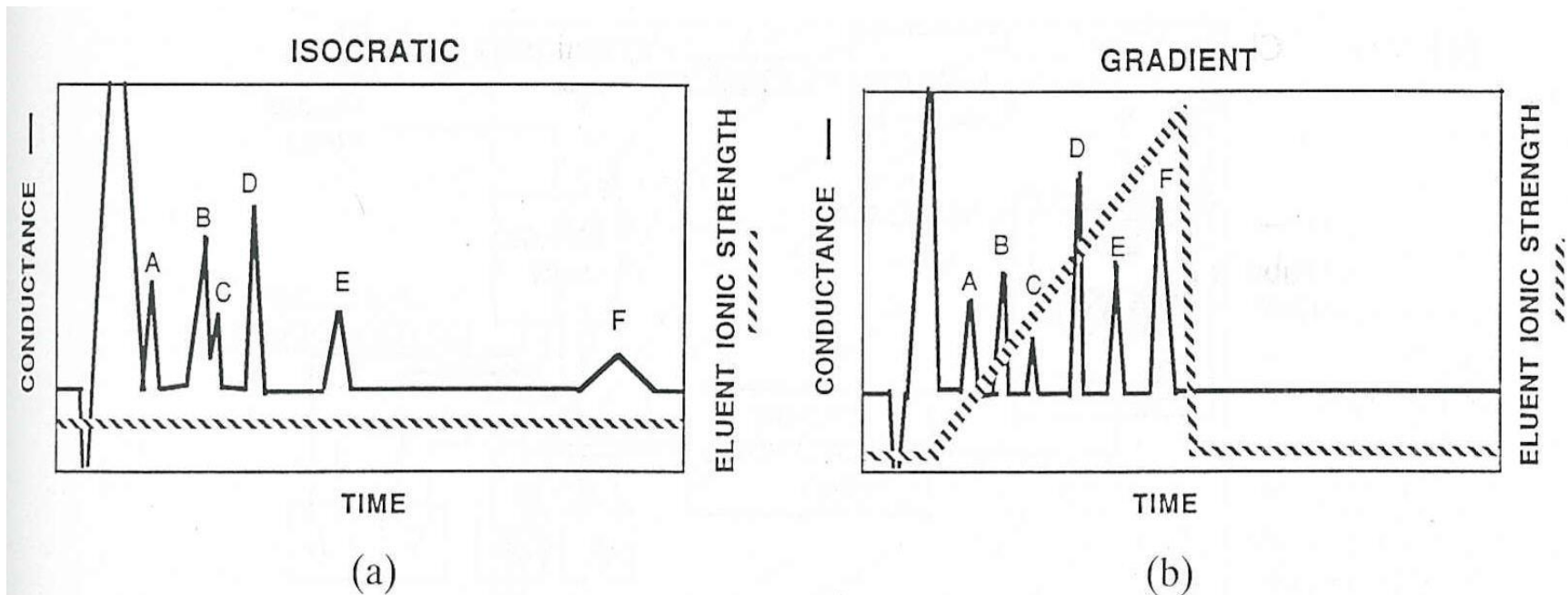

Fig. 5.32. Advantages of a gradient separation. (a) Isocratic separation; (b) gradient separation; solid line is conductance and broken line is eluent ionic strength.

HPLC

Instrumentation

Solvent Delivery Systems

High Pressure Mixing

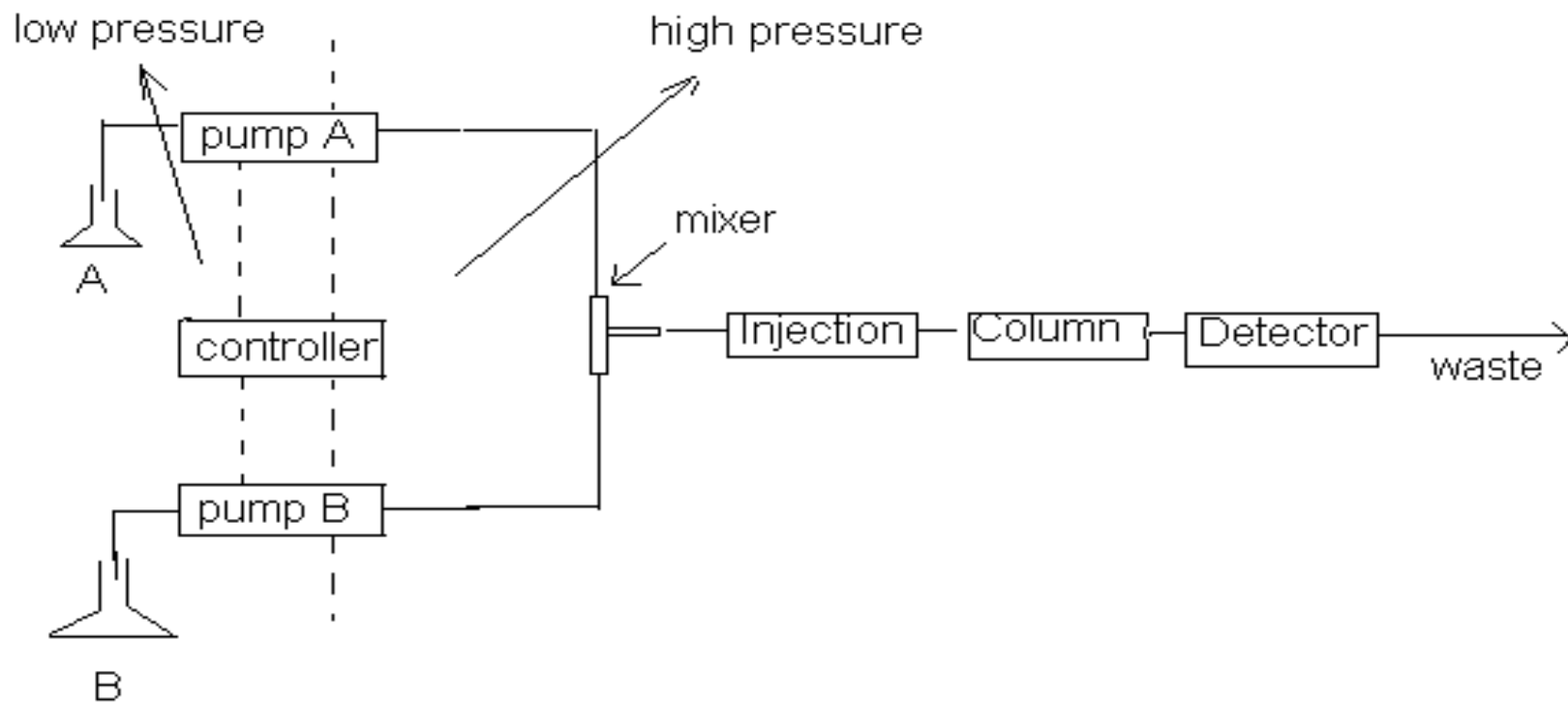

HPLC

Instrumentation

Solvent Delivery Systems

High Pressure Mixing

Use two isocratic pumps – one for each solvent.
Fluid lines are joined with a mixing device or tee.
Amount of each solvent is controlled by separate flow rates.

Works well for very small volumes - capillary.

Has poor precision at the extremes of flow rate ranges, i.e. early or late in the gradient programming.

HPLC

Instrumentation

Solvent Delivery Systems

Low Pressure Mixing

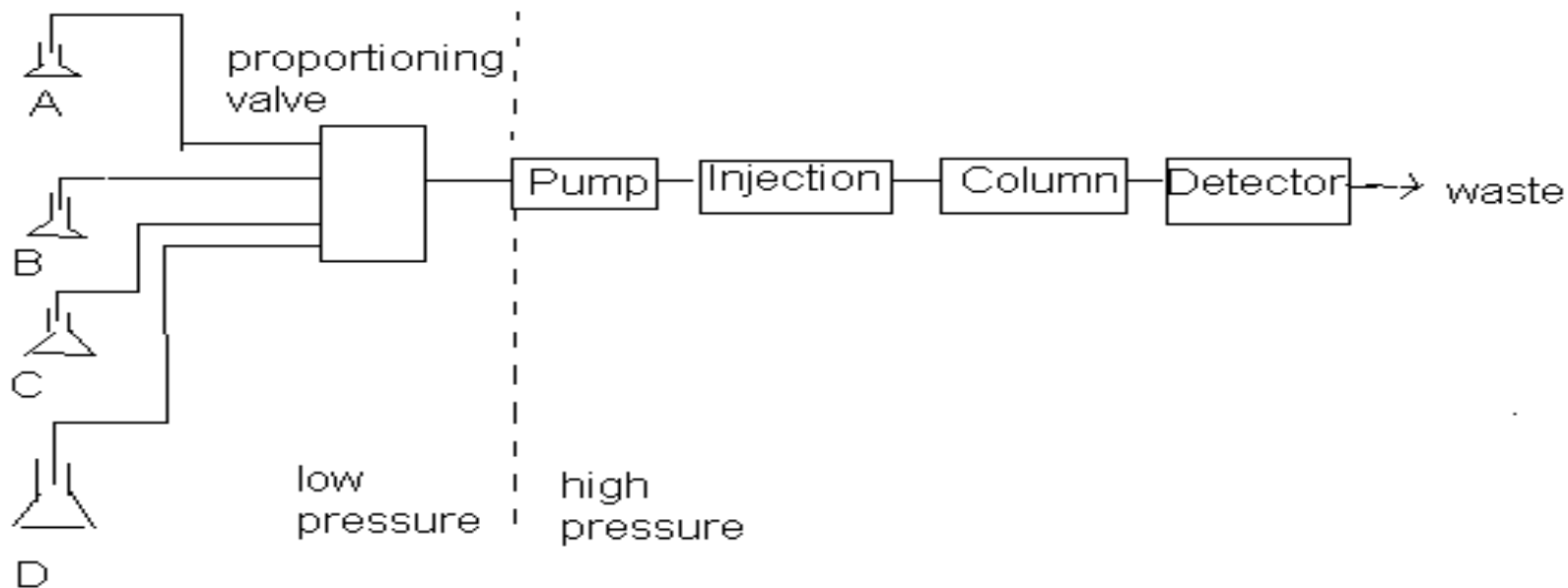

HPLC

Instrumentation

Solvent Delivery Systems

Low Pressure Mixing

Solvents are blended at atmospheric pressure.

Only need a single pump.

Small Teflon block has 4 proportioning valves to combine 4 solvents.

HPLC

Instrumentation

Solvent Delivery Systems - Pumps

Primary Function -- to deliver the mobile phase through the system at a constant flow rate or constant pressure.

Since most HPLC column packings have small particle sizes (3-10 μ m) the backpressures are very high (6000 p.s.i.).

Precise flow rates are needed (<1% variation) since detectors are sensitive to pump pulsation.

HPLC

Instrumentation

Solvent Delivery Systems - Pump Materials

Pump constructed of materials that are inert and chemically resistive.

Many mobile phases for HPLC are acidic or basic-(corrosive).

Most of the contact surface is constructed of 316 stainless steel (SS). SS is passivated in 6 M HNO_3 to resist leaching and chemical attack (exception HCl).

SS – low cost, easy to machine, and sturdy.

HPLC

Instrumentation

Solvent Delivery Systems - Pump Materials

Piston plungers are constructed from sapphire.

Ball, in the ball and seat check is made of ruby and the seat sapphire.

Plunger seals -- made from polymeric material of high molecular weight polyethylene or polypropylene or PTFE.

Washers or spacers – Kelf and ceramics

HPLC

Instrumentation

Solvent Delivery Systems - Reciprocating HPLC pumps

Majority of pumps today use a piston to displace a solvent from small volume (50-250 μl) chambers out of the pump.

Most common is a dual head reciprocating piston pump.

HPLC

Instrumentation

Solvent Delivery Systems - Reciprocating HPLC pumps

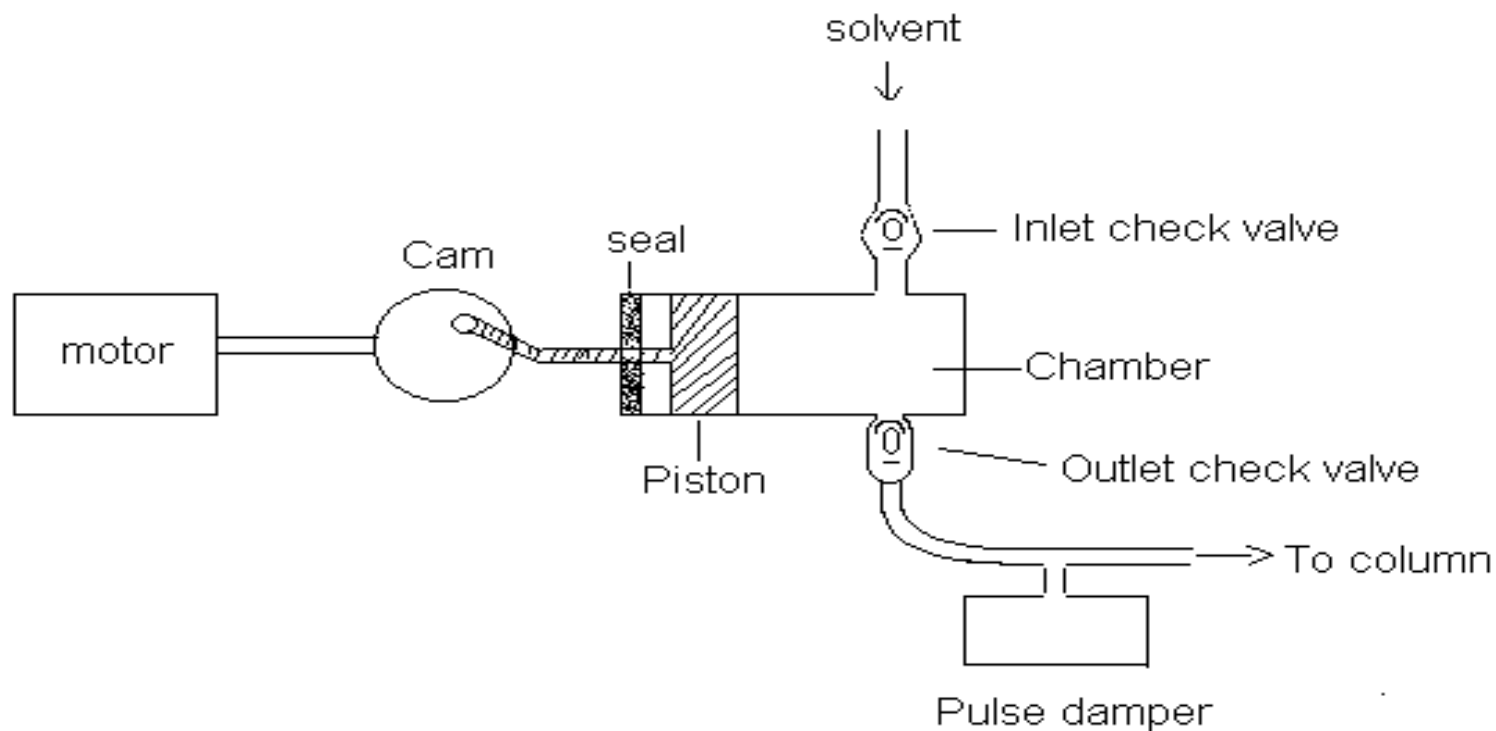

HPLC

Instrumentation

Solvent Delivery Systems - Reciprocating HPLC pumps

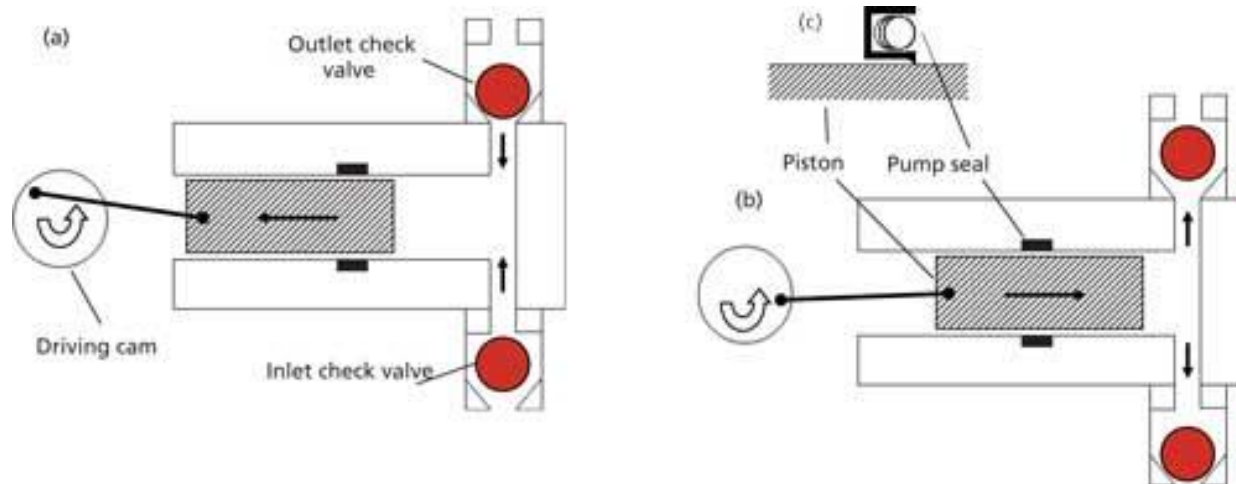

The single-piston pump: (a) suction or fill cycle; (b) pressure or delivery cycle; (c) detail of pump seal.

HPLC

Instrumentation

Solvent Delivery Systems - Reciprocating HPLC pumps

Pump head consists of two sets of moving parts:
Check valves (Ball & Seat) and Seal-Piston assembly.

Cam and connecting rod transform the rotational movement of the motor into linear movement of the piston. Each stroke of the piston displaces a small volume of liquid from a chamber.

HPLC

Instrumentation

Solvent Delivery Systems - Reciprocating HPLC pumps

For the fill stroke:

- The piston is withdrawn into the chamber.
- Inlet check (ball) valve rises from its seat since incoming solvent is at higher pressure than pressure inside the liquid chamber.
- Outlet check (ball) valve drops into its seat since pressure on column side is higher than that inside the pump head.

For the delivery stroke:

- Piston moves into liquid chamber and pressurizes the liquid.
- Inlet check valve closes since pressure inside chamber is greater than outside (solvent side).
- Outlet check valve opens when pressure inside the pump head exceeds the pressure on the column side.

HPLC

Instrumentation

Solvent Delivery Systems - Reciprocating HPLC pumps

Check valves open alternatively.

The solvent flow from each of the pump heads combine to obtain a steady composite flow.

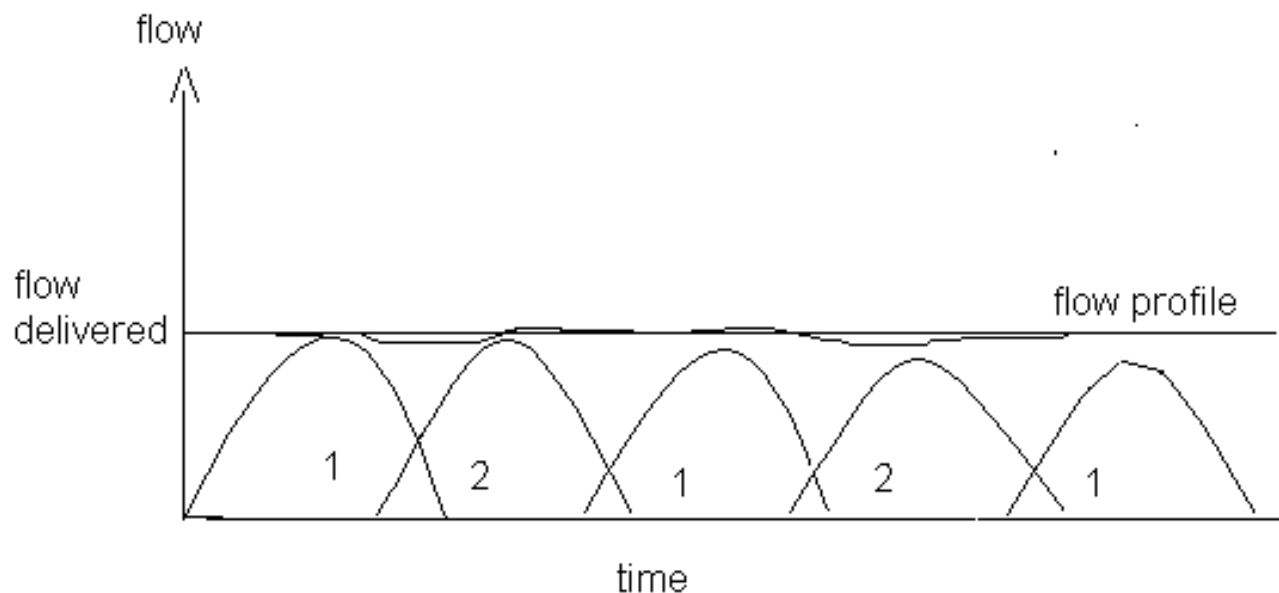

HPLC

Instrumentation

Solvent Delivery Systems - Reciprocating HPLC pumps

Pump pulsations give baseline noise in the detector.

Often additional features are added to minimize pulsations.

Pulse dampers - (Noise Filters) – between pump and the injection.

Long lengths of very narrow tubing folding back on themselves many times.

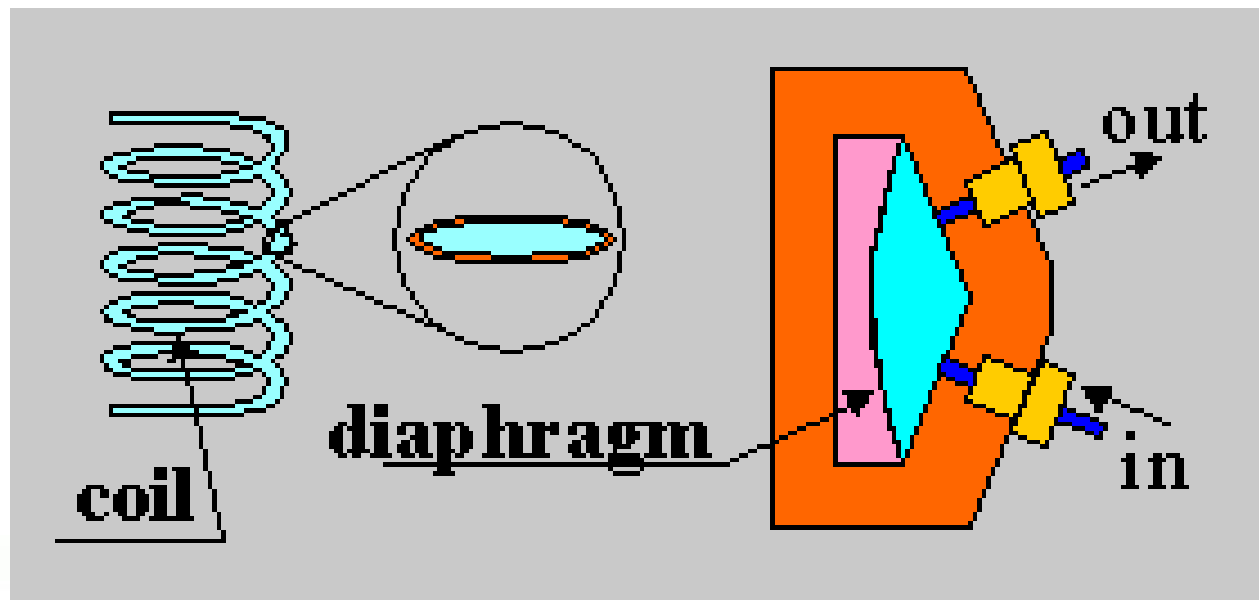

High Performance Liquid Chromatography (HPLC)

Instrumentation

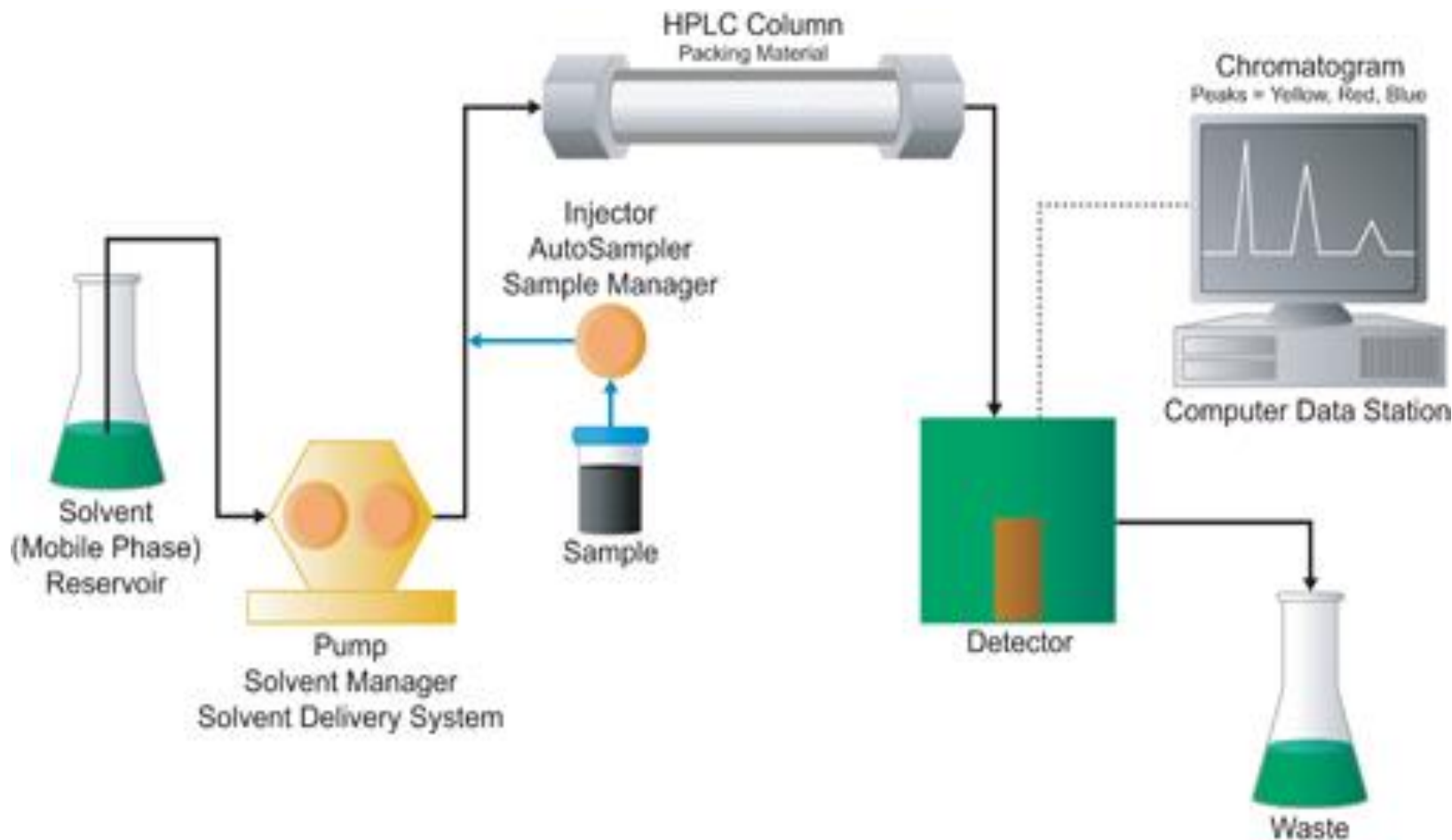

HPLC

Instrumentation

Sample Injection

Function – to introduce sample into flowing stream prior to the column.

Manual and automatic injections

Goal – minimize dispersion and broadening of peaks (sample injected as sharp plug).

HPLC

Instrumentation

Sample Injection - Manual Injection

Valve type injectors most widely used.

Most common is six-port Valco or Rheodyne injector.

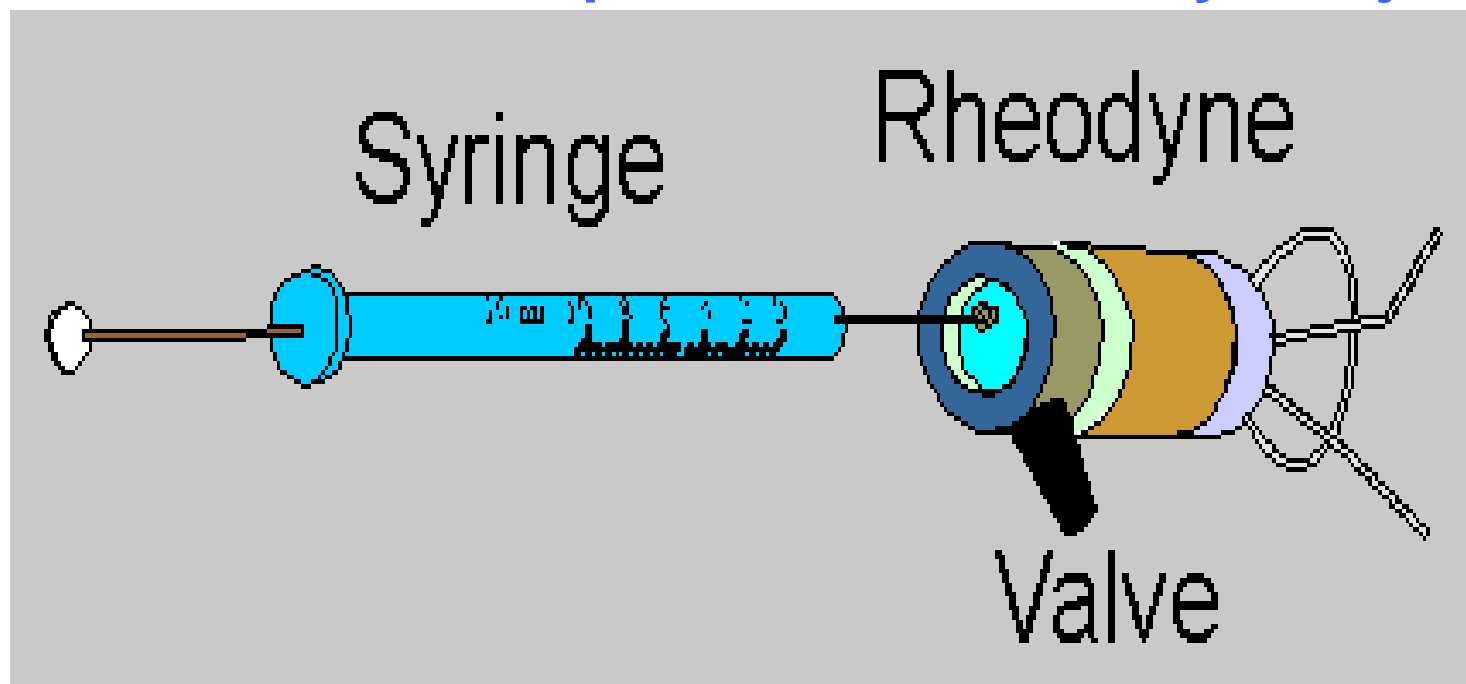

HPLC

Instrumentation

Sample Injection - Manual Injection

Two positions – load and inject.

Load position – mobile phase bypasses the sample loop and flows directly into the column. Sample loop is filled with a microsyringe through the needle port.

Inject position – Mobile phase – backflushes the sample from the loop into the column.

Sample loop size may be varied.

Precision is 0.05% to 0.1%.

HPLC

Instrumentation

Sample Injection - Manual Injection

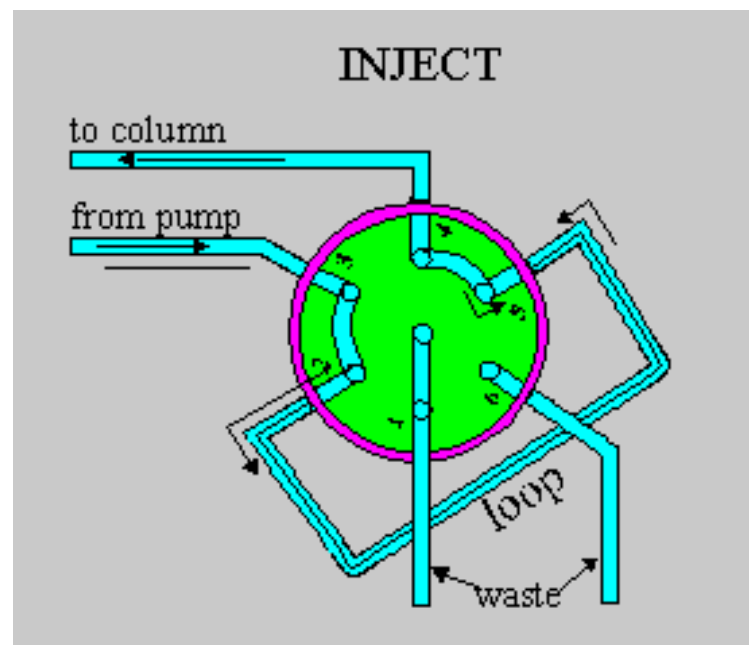
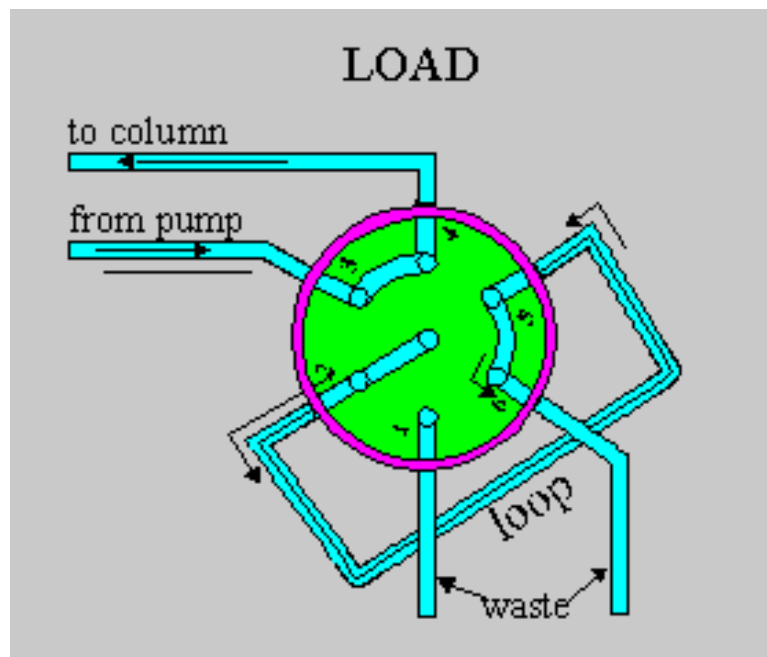

HPLC

Instrumentation

Sample Injection - Automated Injection

Called autosamplers or autoinjectors

Function the same as the valve-operated manual injectors- except the sample is introduced from a vial held in a sample tray using a syringe assembly controlled by a stepping motor and the valves are automatically actuated.

High Performance Liquid Chromatography (HPLC)

Instrumentation

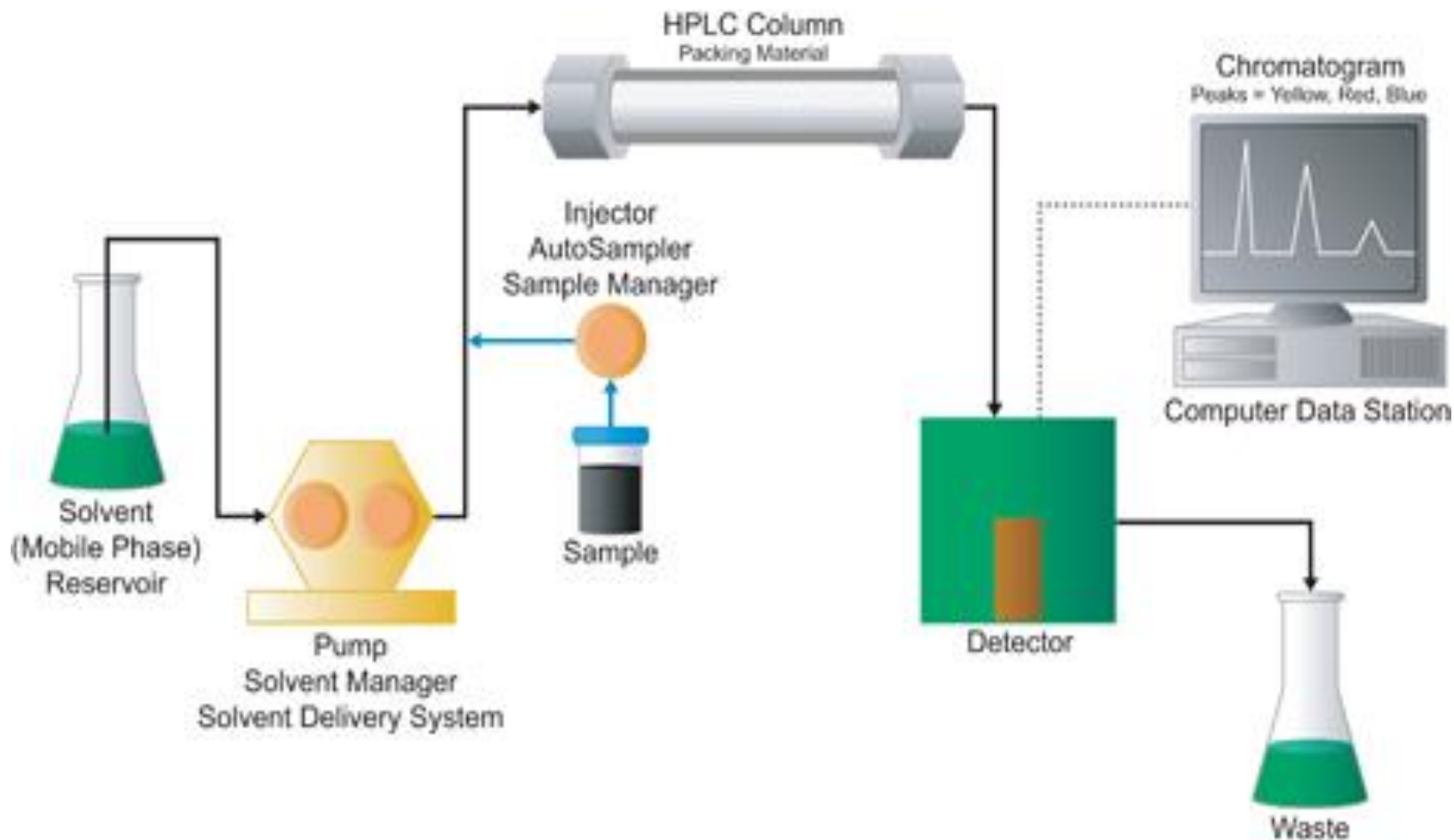

HPLC

Instrumentation

Columns

Scale	Chromatographic Objective
Analytical	Information [compound ID and concentration]
Semi-preparative	Data and a small amount of purified compound [< 0.5 gram]
Preparative	Larger amounts of purified compound [> 0.5 gram]
Process [Industrial]	Manufacturing quantities [grams to kilograms]

Scale	1- 8mm Column Diameter	10- 40mm Column Diameter	50-100mm Column Diameter	> 100mm Column Diameter	Particle Size micron
Analytical	X				1.7 -10
Semi-Prep		X			5 - 15
Prep			X		15 -100
Process				X	100+

HPLC

Instrumentation

Columns

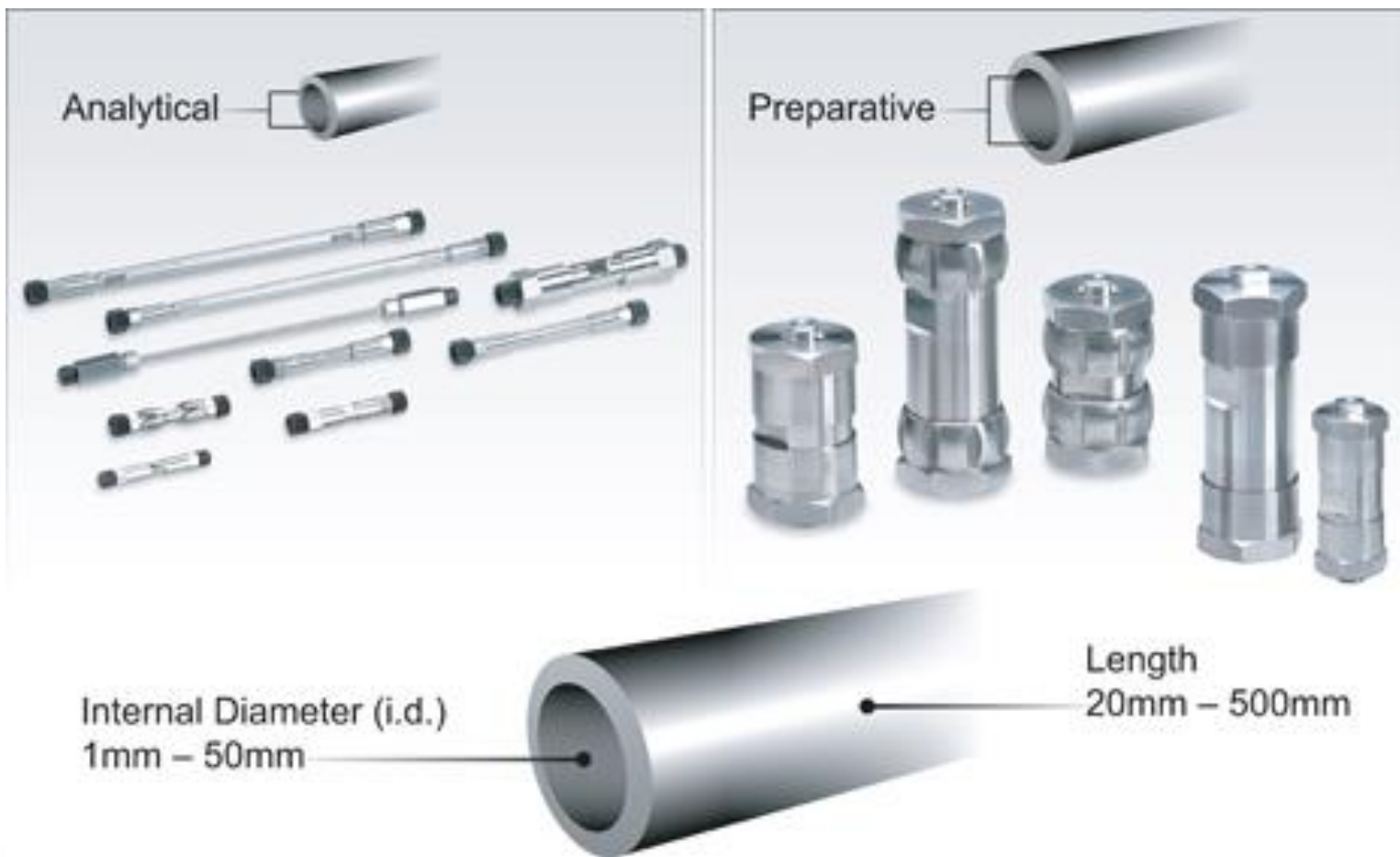

HPLC

Instrumentation

Columns

Column tube and fittings must contain the chromatographic packing material [stationary phase] that is used to effect a separation.

- must withstand backpressure
- must provide a leak-free, minimum-volume, and zero-dead-volume flow path for the sample
- must be chemically inert relative to the separation system

HPLC

Instrumentation

Columns

Most columns are constructed of stainless steel for highest pressure resistance.

PEEK™ [an engineered plastic] and glass, while less pressure tolerant, may be used when inert surfaces are required for special chemical or biological applications.



HPLC

Instrumentation

Columns - Stationary Phases

Most HPLC packings are microparticles of varying size, shape, and porosity.

Silica packings are popular- can withstand high pressure, is abundant, and inexpensive. Functional groups can be bonded to the silica.

Disadvantage- unstable at high and low pH

Resin-based packings are being used more in HPLC columns.

Advantage – used over a wide range of pH

Disadvantage – must be used at lower pressures than silica.

HPLC

Instrumentation

Columns - Stationary Phases

Commercial resins:

Polystyrene – divinylbenzene

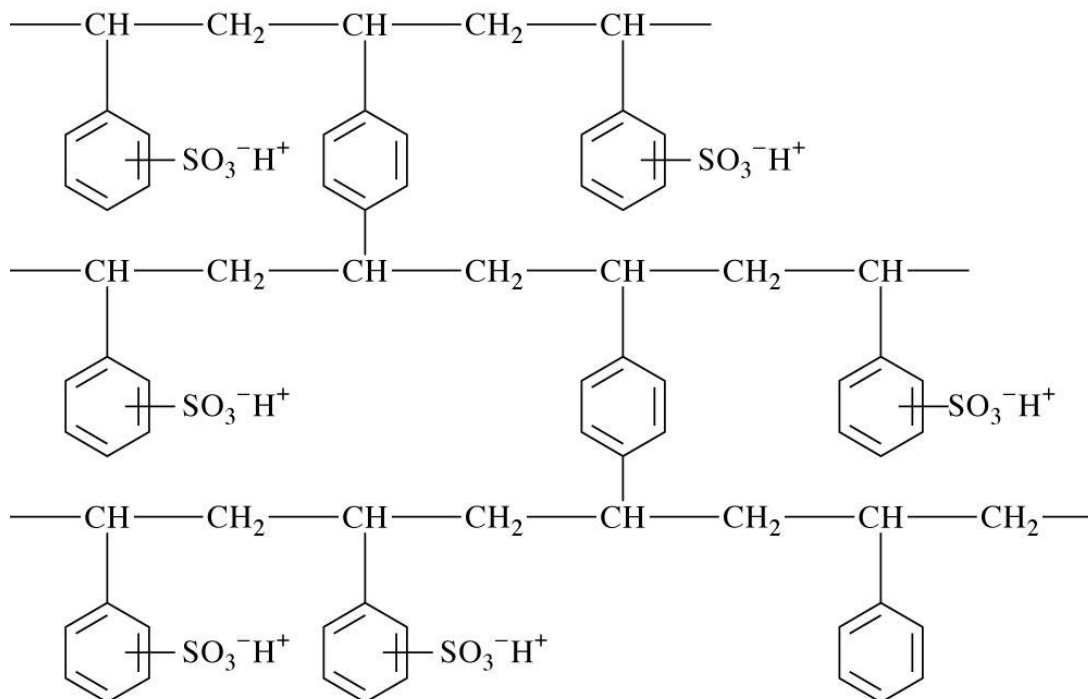

© 2007 Thomson Higher Education

HPLC

Instrumentation

Columns - Stationary Phases - Particle Types

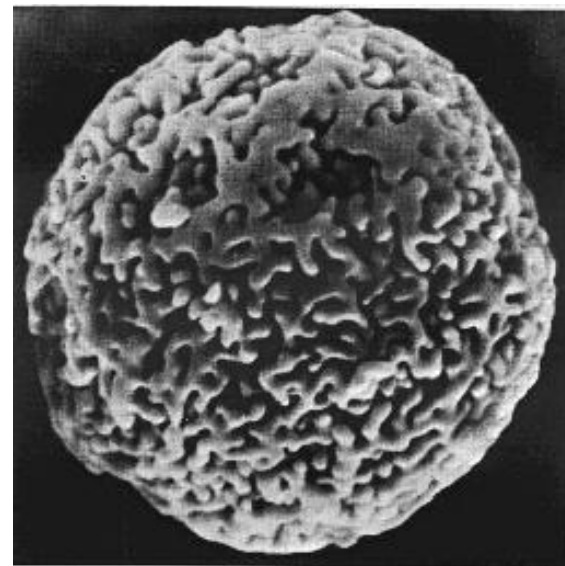
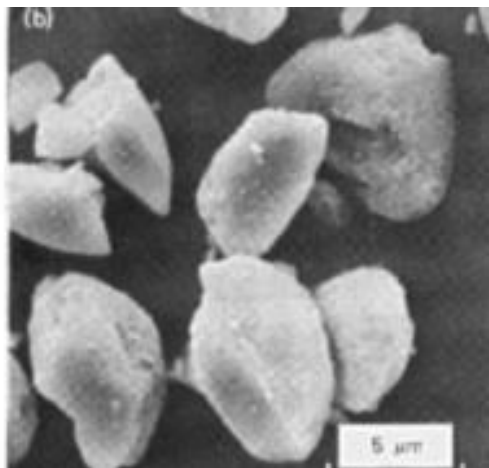
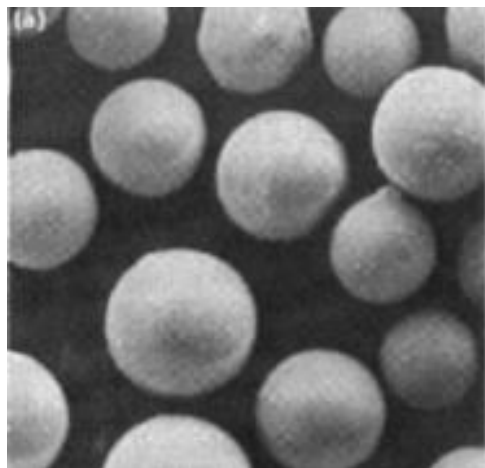

HPLC

Instrumentation

Columns - Stationary Phases - Particle Types

Totally porous particles (20-40 μm)

Long pores filled with stagnant mobile phase

These have relatively low efficiency and so are not used much.

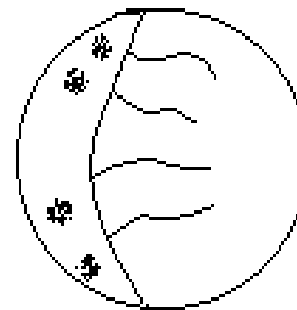
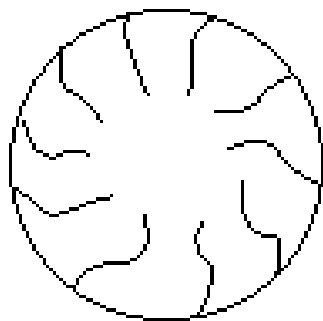

HPLC

Instrumentation

Columns - Stationary Phases - Particle Types

Totally porous microparticle (5-10 μm)

Fully porous materials that can be either irregular or spherical in shape.

Spherical materials have better stability at high pressures, larger sample volume capacity, and better detection sensitivity.

Have high efficiency and speed for trace analysis and large peak capacity.

Particles with small pores exhibit a high surface area and have greater retention.

Pore sizes are classified as a statistical distribution. A narrow distribution is preferred.

HPLC

Instrumentation

Columns - Stationary Phases - Particle Types

Pellicular Particle (~20-40 μm)

Thin layer of adsorbent or stationary phase

Solid spherical bead with thin outer surface of stationary phase

Give higher efficiencies than porous particles of the same size but restricted to small sample loadings (low surface area).

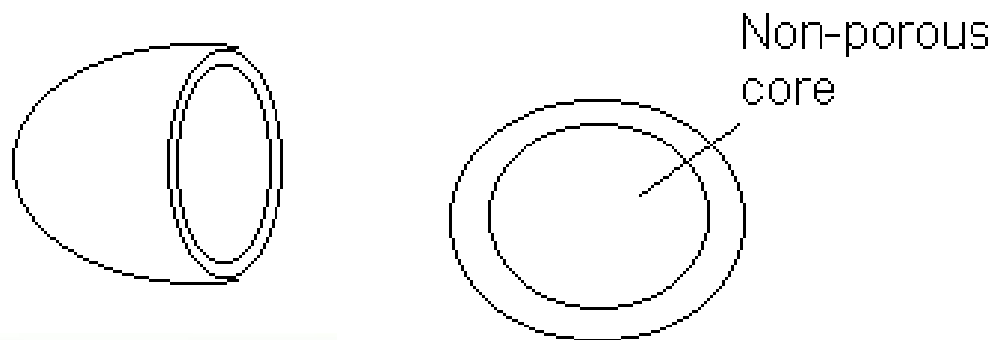

HPLC

Instrumentation

Columns - Column Packing Methods

Dry-fill procedure

For packing of rigid solids and resins with particle diameter $> 20 \mu\text{m}$ (pellicular materials)

Degrease and dry interior of tubing.

Place porous screen ($\sim 2 \mu\text{m}$) in outlet fitting of column.

Add small amount of packing material into vertical column via a funnel.

Tap column to settle packing and repeat. Packing is leveled off and inlet fitting with screen is screwed onto column.

Method works well for large porous particles or pellicular materials.

HPLC

Instrumentation

Columns - Column Packing Methods

Wet-fill or slurry Procedure

A suitable liquid is used to suspend particles.

Slurry is pumped under high pressure into empty column.
When a constant flow rate is obtained, packing is complete.

Packing is leveled off and inlet fitting with screen added.

Solvent used must wet the packing thoroughly and maintain a uniform particle distribution.

High surface energy materials, i.e. unfunctionalized silica, require polar solvents.

Low surface energy materials, i.e. C₁₈, need less polar solvents.

HPLC

Instrumentation

Columns – Column Performance

Column performance can be evaluated using the number of theoretical plates (N), peak asymmetry, capacity factor, selectivity, resolution of critical peak pair, etc...

Determination of N using a “test” compound is most widely used by manufacturers. Typical test compounds include pyridine, uracil and acenaphthene for C18 columns.

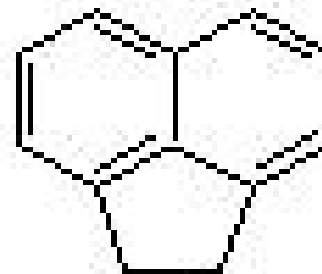
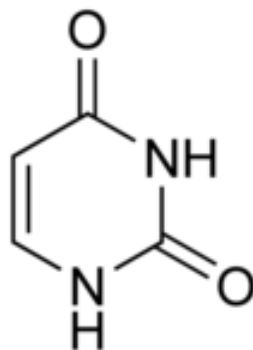
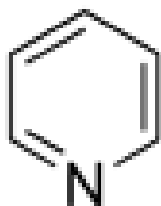

Acenaphthene

HPLC

Instrumentation

Columns – Column Care

Column care

- follow manufacturer recommendation for mobile phase pH, flow rates, organic modifier content, temperature, operating pressure.
- use only HPLC solvents
- use only HPLC water to prepare solvents, standards, and samples
- always filter and sparge mobile phases
- only alter mobile phase flow rates in small increments to avoid sudden backpressure
- use guard columns whenever possible***
- store columns in appropriate solvents (i.e. methanol for C18)

Assignment

- Read Chapter 28
- Homework Chapter 28: 2-12, & 15
- HW16 Chapter 28 Due 4/19/24

